

PARCO DEL BRENTA

Via Cerom, 202 - PADOVA

UNITA' 6



PIANTA PIANO TERRA

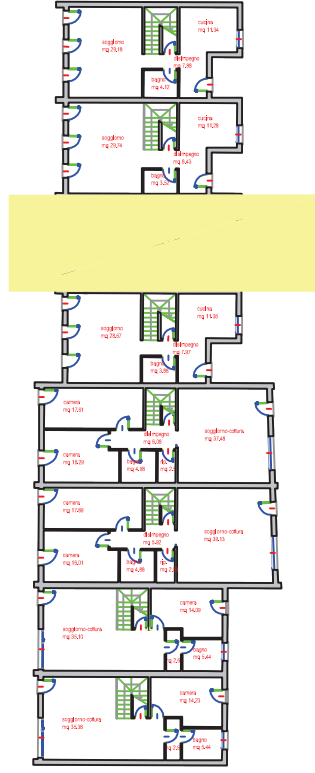

Giardino privato
Unità 6 mq. 41

soggiorno
mq 29.31

bagno
mq 4.44

disimpegno
mq 7.88

cucina
mq 11.34

Corile privato
Unità 6 mq. 35

SEZIONE

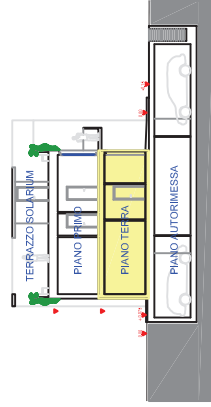

DATI TECNICI

Superficie commerciale : 192.34 m²

Ingresso disimpegno 7.88 m²

Cucina 11.34 m²

Ripostiglio 2.00 m²

Bagno 4.44 m²

Soggiorno 29.31 m²

Cortile + giardino 76.00 m²



Galiuzzo fratelli costruzioni s.r.l.

PARCO DEL BRENTA

Via Cerom, 202 - PADOVA

UNITA' 6

PIANTA PIANO PRIMO

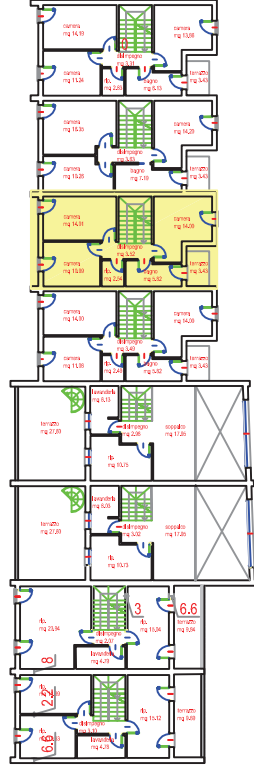

SEZIONE

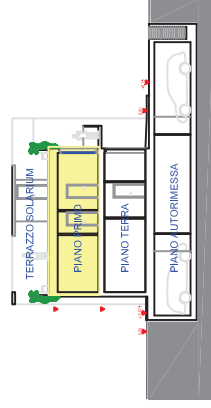

DATI TECNICI

Superficie commerciale : 192.34 m²

Idisimpegno	3.31 m ²
Camera	13.86 m ²
Ripostiglio	2.63 m ²
Bagno	6.13 m ²
Camera	14.72 m ²
Camera	11.24 m ²

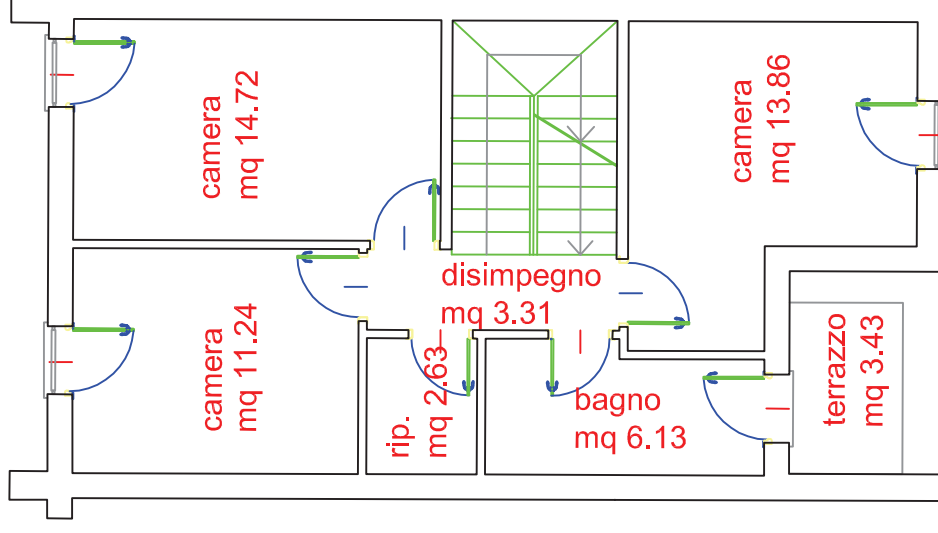

PARCO DEL BRENTA

Via Cerom, 202 - PADOVA

UNITA' 6



PIANTA PIANO AUTORIMESSA

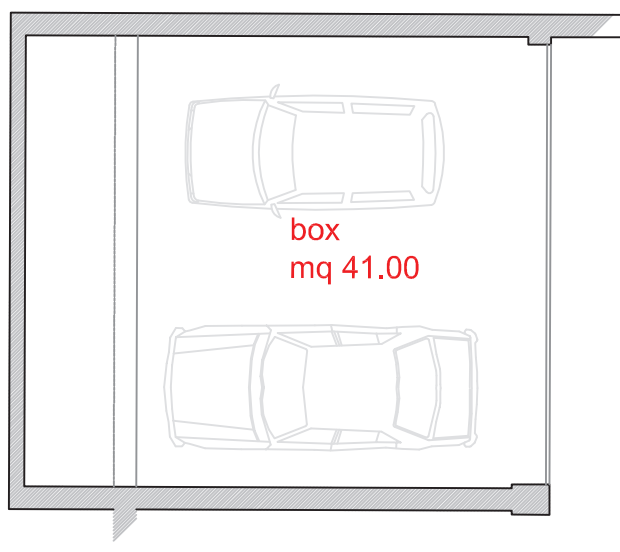
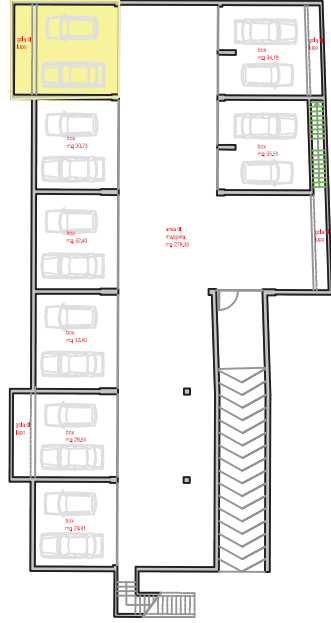

SEZIONE

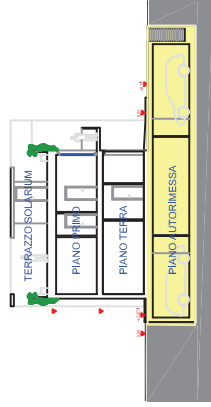

DATI TECNICI

Superficie commerciale : 192.34 m²

Garage mq. 41.00

NP: Per stampare in scala 1:100 (1 cm equivalente a 1 mt), nella finestra di stampa del vostro driver PDF, all'impostazione "ridimensionamento pagina" selezionare "nessuno".



Gializzo fratelli costruzioni s.r.l.